

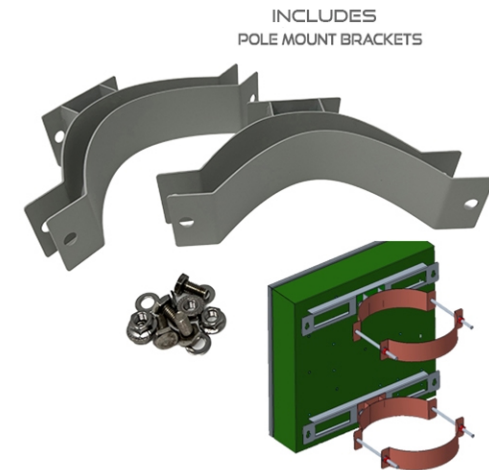

6 Panel Extra Heavy Duty Steel Outdoor Wall / Pole Mount Fiber Optic Enclosure with LGX Chassis, 3 x 12 Fiber Splice Trays, Splice Sleeves, and Locking Door with Key

SKU: QT-6P-EHDS-OFOE-36S



OVERVIEW

Our QuickTreX® 6 Panel Extra Heavy Duty Steel Outdoor Wall / Pole Mount Fiber Optic Enclosure with LGX Chassis, 3 x 12 Fiber Splice Trays, Splice Sleeves, and Locking Door with Key is perfect for interconnectivity and termination of optical fibers in outdoor harsh environment locations. Its made of heavy gauge special coated steel providing a superior UV and waterproof protection of your fiber optic connectors and splices. The enclosure is out most crush resistance and durable box we offer. It is compatible with all standard LGX adapter panels. This enclose includes wire management rings to easy spool your cable inside the box. It also includes three removable 12 fiber splice trays so you can use it for splicing fiber pig tails or for pre-terminated fiber optic assemblies. The enclosure includes an excellent sealing strip, rubber gromets, and cable glands to help seal out moisture and dust. It also includes a lockable door and special grooved locking nut with key to help protect from anyone accessing the box. This box is also great for indoor installations such as warehouses, factories, and heavy industrial settings where lots of dust and potential contamination takes place.

SPECIFICATIONS

Dimensions:	18.31" W x 15.1" W x 4.33" D
Panels:	6 LGX (See Dropdown for Available Panels)
Splice Tray:	3 Removable 12 Fiber Splice Trays (Included)
Splice Sleeves:	36 Included
Fiber Capacity:	Up to 144 Fiber Connectors Depending on Connector Type
Material:	Cold Rolled Steel with Static Spreading Plastic Coating
Color:	Off-White
Wire Management:	8 Fiber Management Spools and 3 Cable/Hose Clamps
Cable Entry / Exit:	4 Total (3 x 7/8" Glanded or Grommet Options On Left Side) and (1 x 1.5" Grommeted)
Weight:	14.4 lbs

INCLUDES

- (3) 7/8" Glanded Grommets
- (3) 7/8" Split Gromets
- (1) 1.5" Split Grommet
- (3) 12 Fiber Splice Trays
- 36 Splice Sleeves
- (3) Cable/Hose Clamps
- (8) Fiber Management Spools
- Mounting Screws w/ Anchors
- Special Door Key
- (2) Heavy Duty Pole Mount Brackets

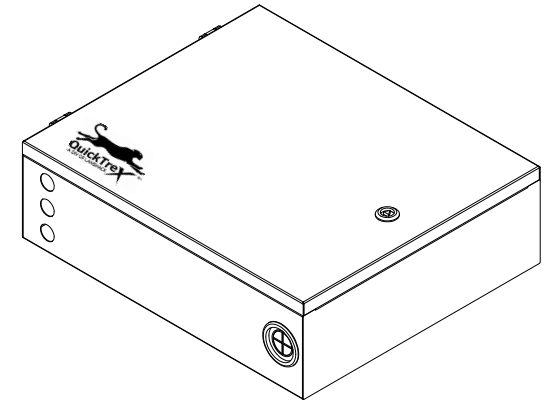

Drawings

Measurements (mm)

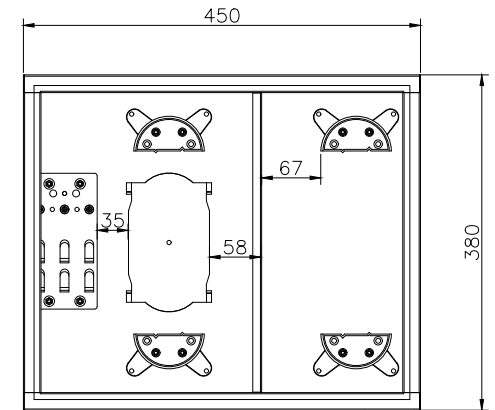
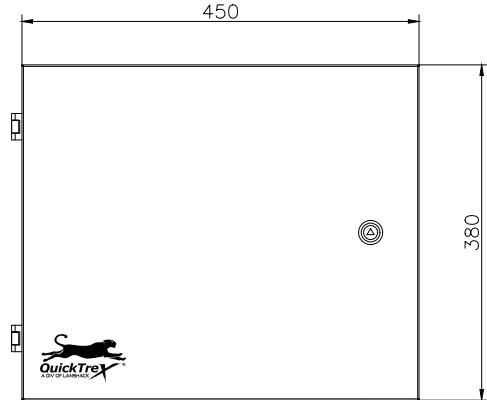
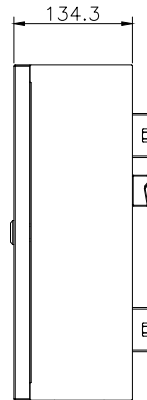
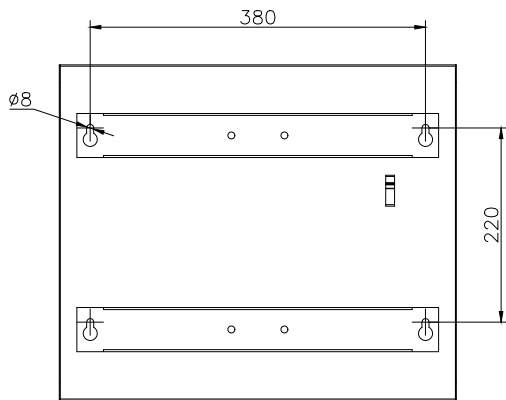
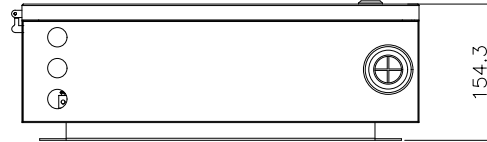

Purchase at

LANshack

Sales@LANshack.com | 888-568-1230